

(12) UK Patent Application (19) GB (11) 2 305 051 (13) A

(43) Date of A Publication 28.03.1997

(21) Application No 9518439.6

(22) Date of Filing 08.09.1995

(71) Applicant(s)
Orad Hi-Tec Systems Limited
(Incorporated in Israel)

PO Box 695, 40 Ravutski Street, Ra'anana 43106,
Israel

(72) Inventor(s)
Itzhak Wilf
Avi Sharir
Michael Tamir

(74) Agent and/or Address for Service
Eric Potter Clarkson
St Mary's Court, St Mary's Gate, NOTTINGHAM,
NG1 1LE, United Kingdom

(51) INT CL⁶
H04N 5/272

(52) UK CL (Edition O)
H4F FD12X FD2A FD2B FGJ

(56) Documents Cited
GB 2271241 A GB 2013448 A GB 2002989 A
WO 93/06891 A1 US 5353392 A US 5264933 A

(58) Field of Search
UK CL (Edition N) H4F FAAD FAAP FAAX FGG FGH
FGJ FGS FGT
INT CL⁶ H04N 5/225 5/232 5/262 5/265 5/268 5/272
5/275
Online: WPI

(54) Automatic electronic replacement of billboards in a video image

(57) Apparatus for automatic electronic replacement of a billboard in a video image including an automatic camera orientation measurement apparatus including motion measurement means operative to measure the Field of View (FOV) of the TV camera relative to a known reference position. The billboard preferably comprises a patterned chroma-key panel and the motion measurement includes measurement of camera pan, tilt, zoom and focus relative to known reference positions.

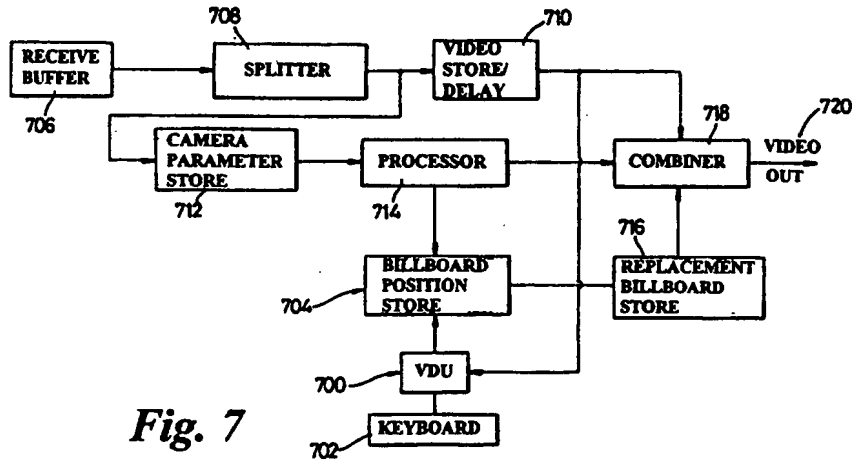

Fig. 7

At least one drawing originally filed was informal and the print reproduced here is taken from a later filed formal copy.

GB 2 305 051 A

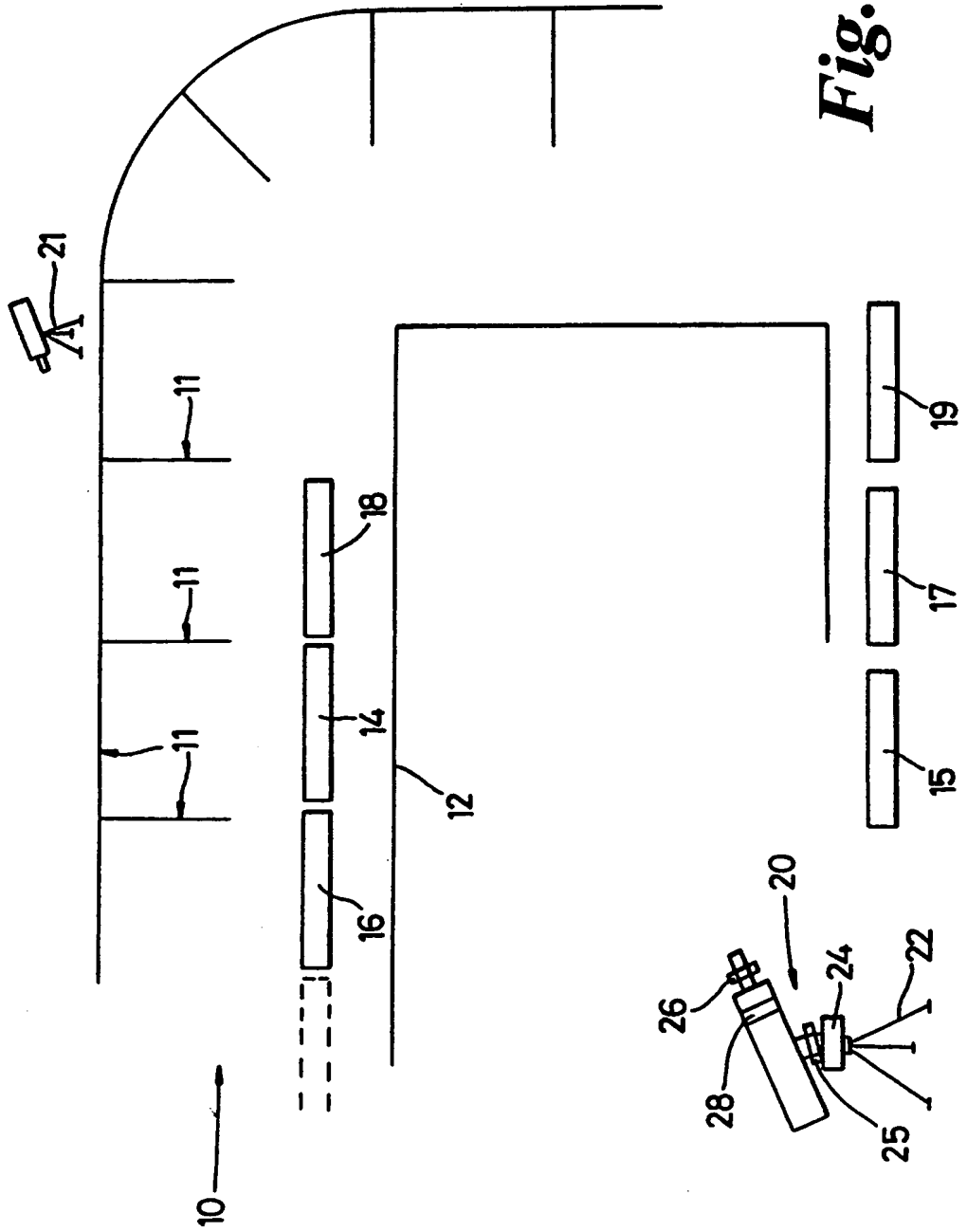

Fig. 1

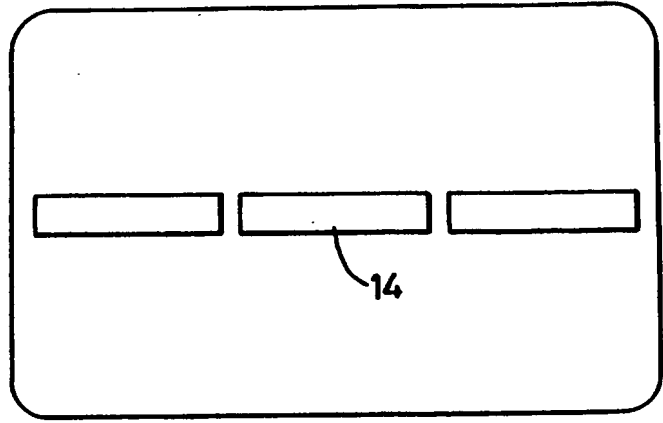

Fig. 2

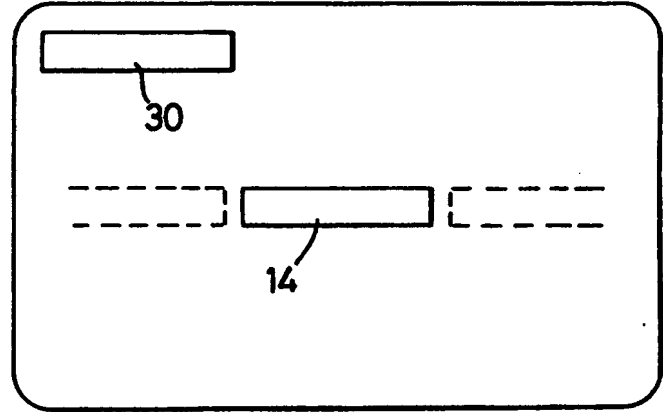

Fig. 3

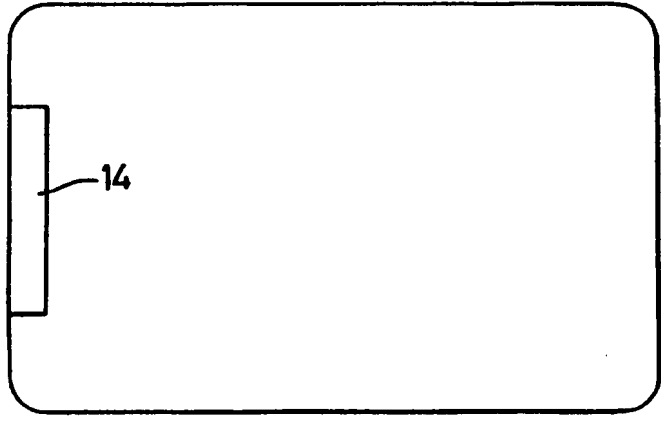

Fig. 4

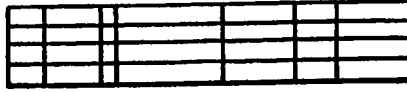

Fig. 5

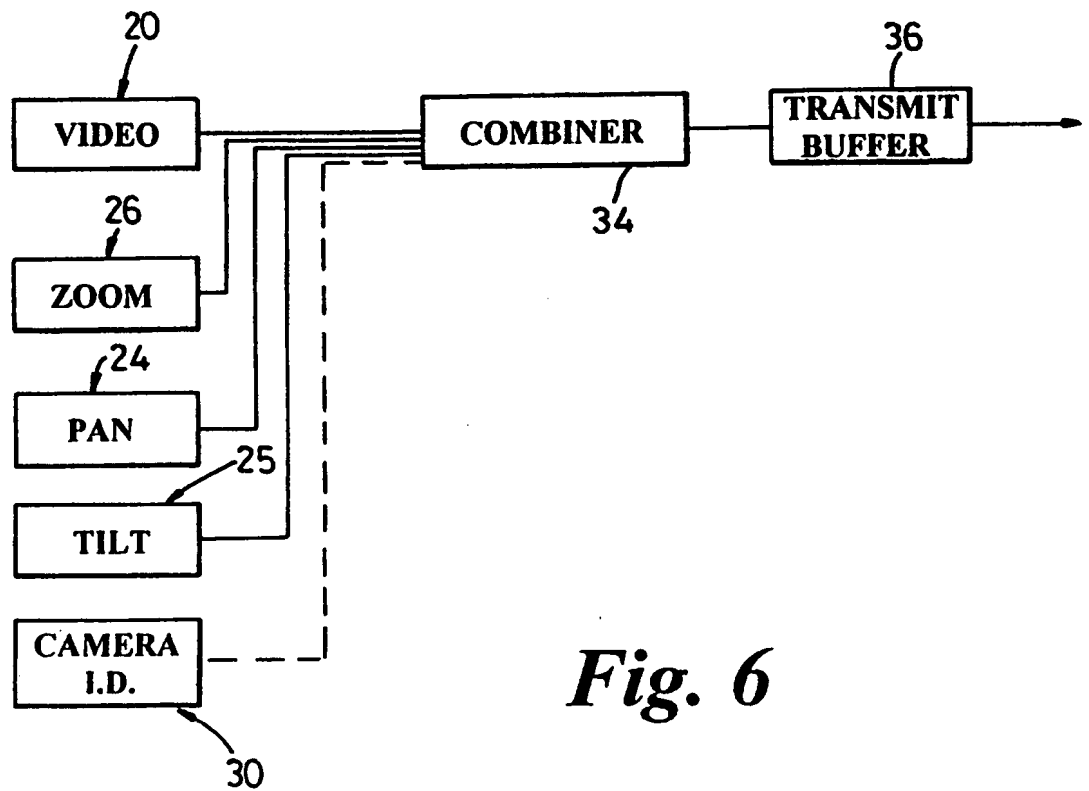

Fig. 6

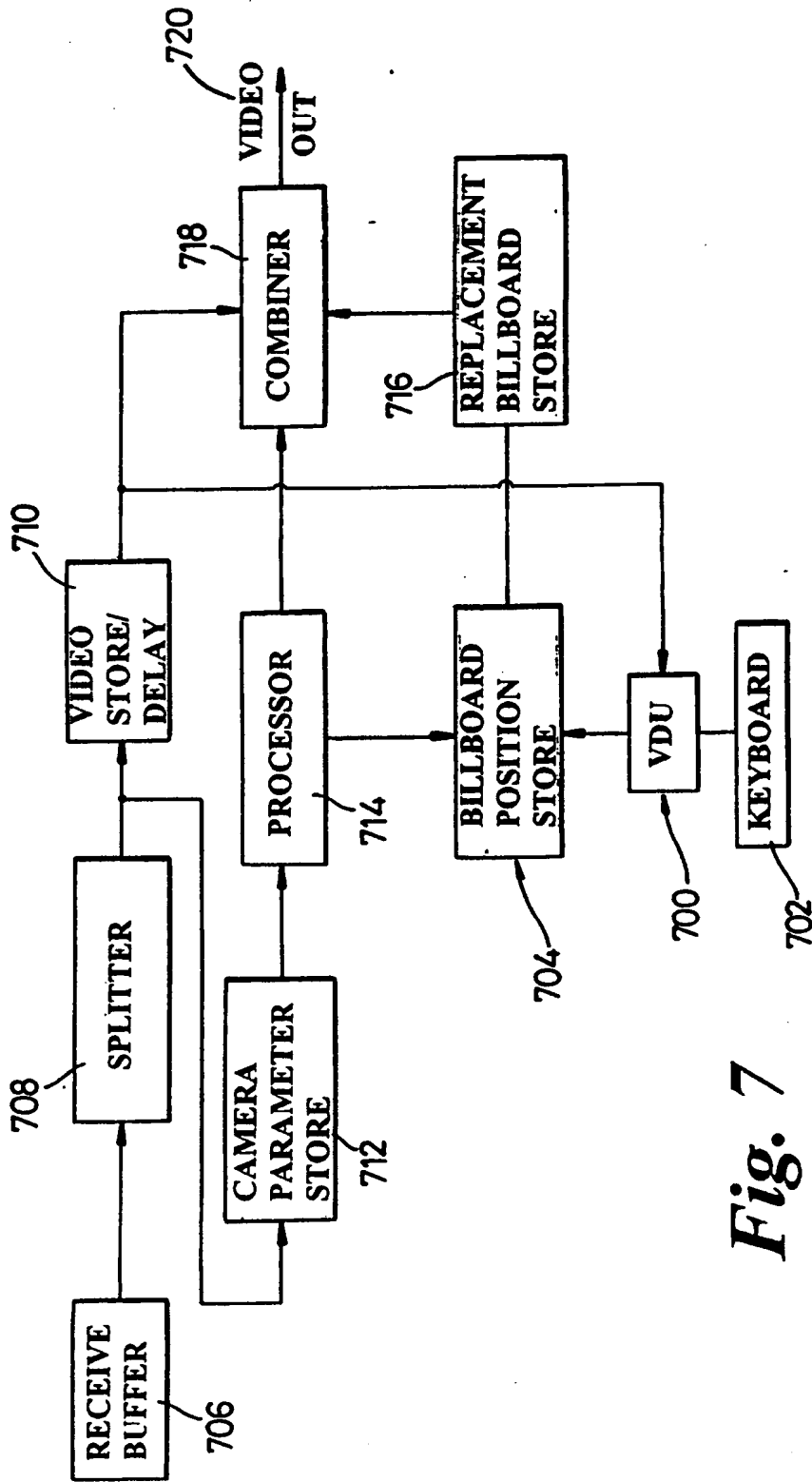

Fig. 7

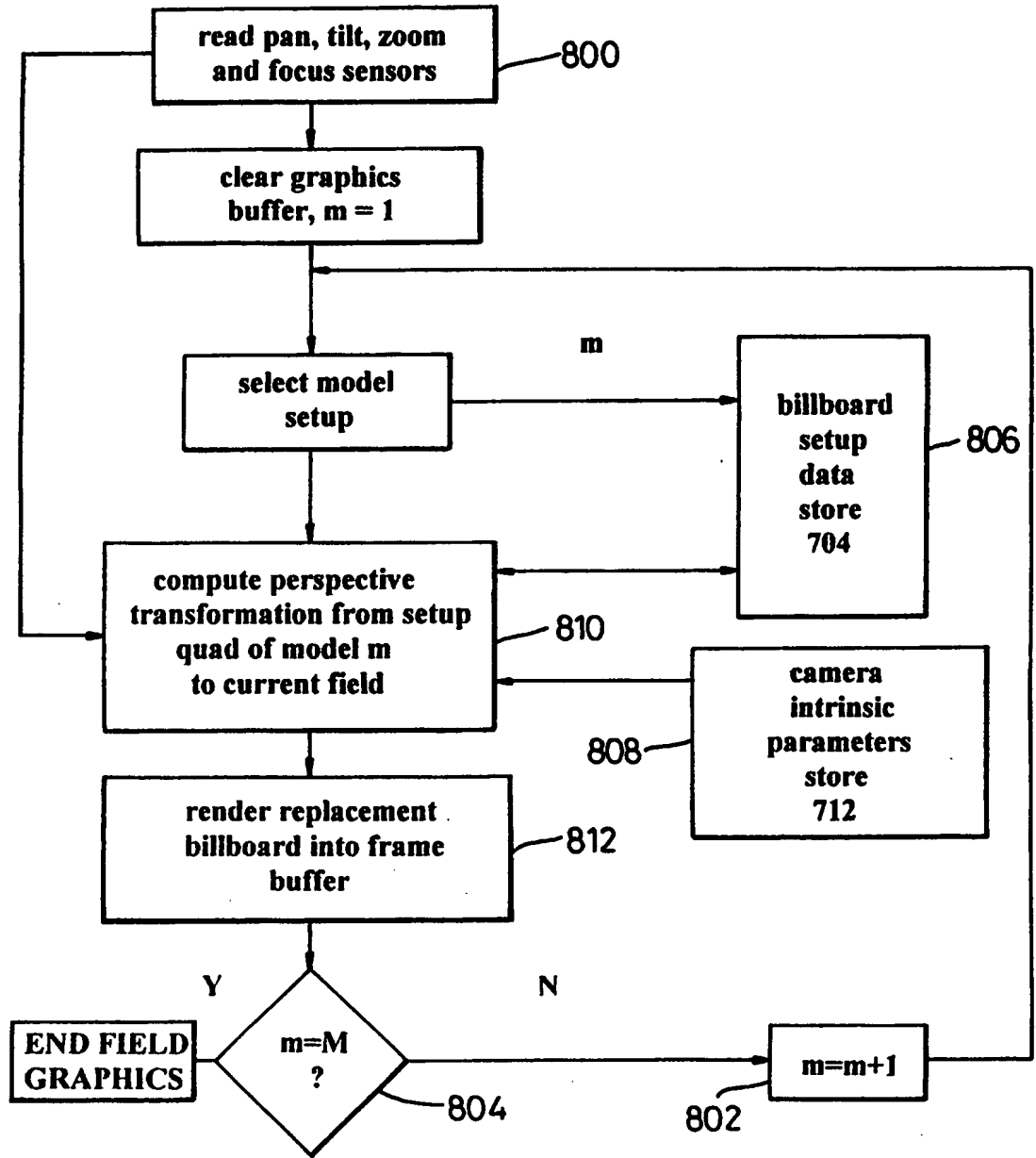

Fig. 8

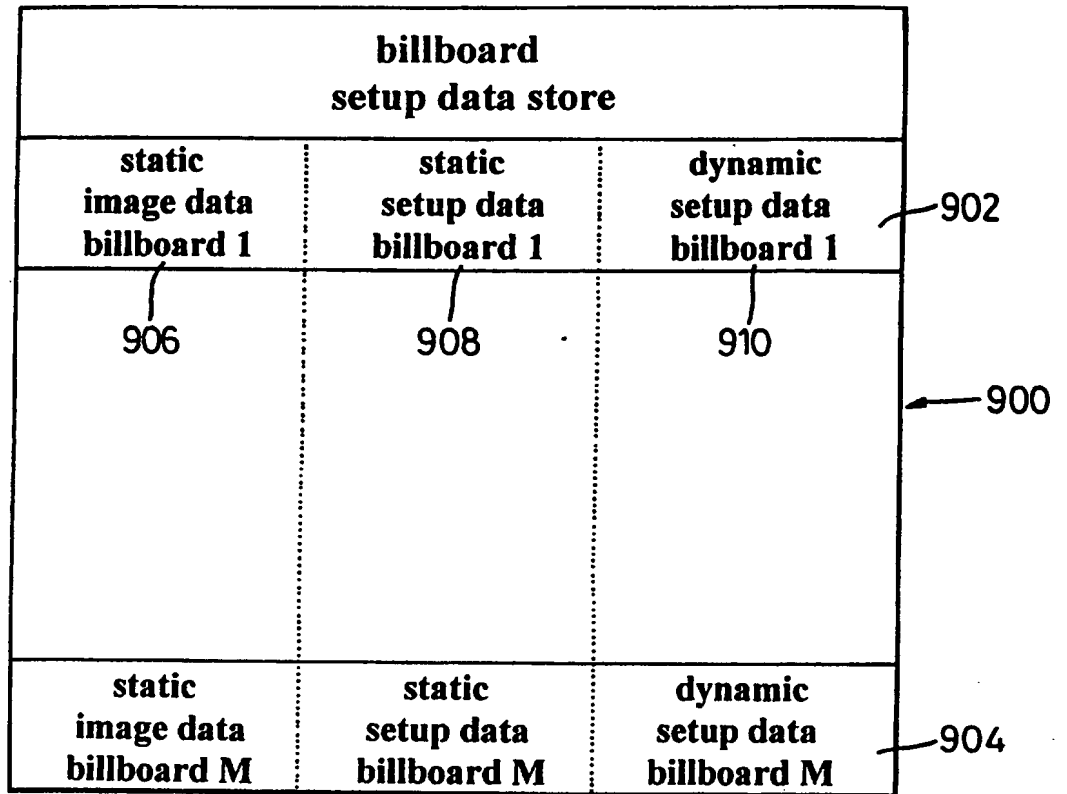
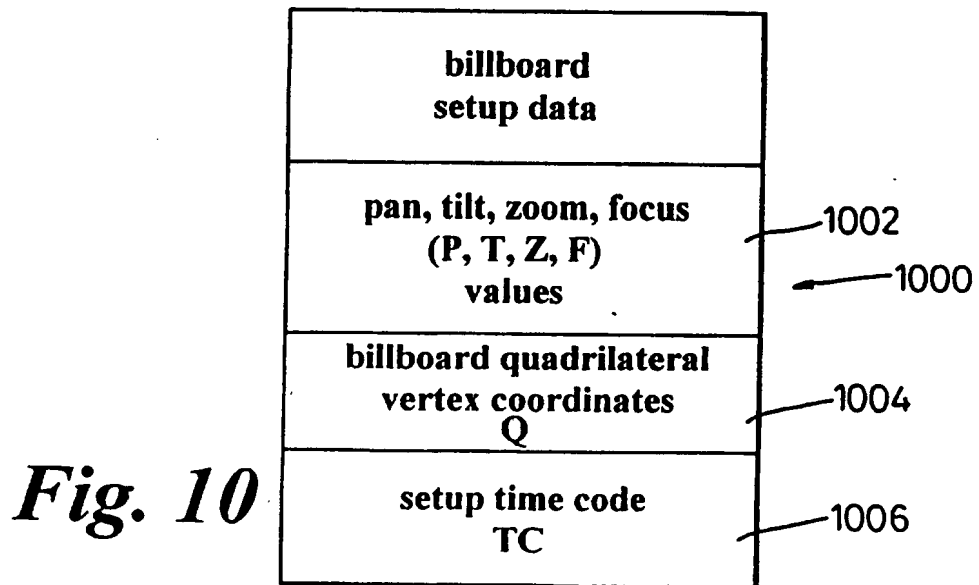

Fig. 9



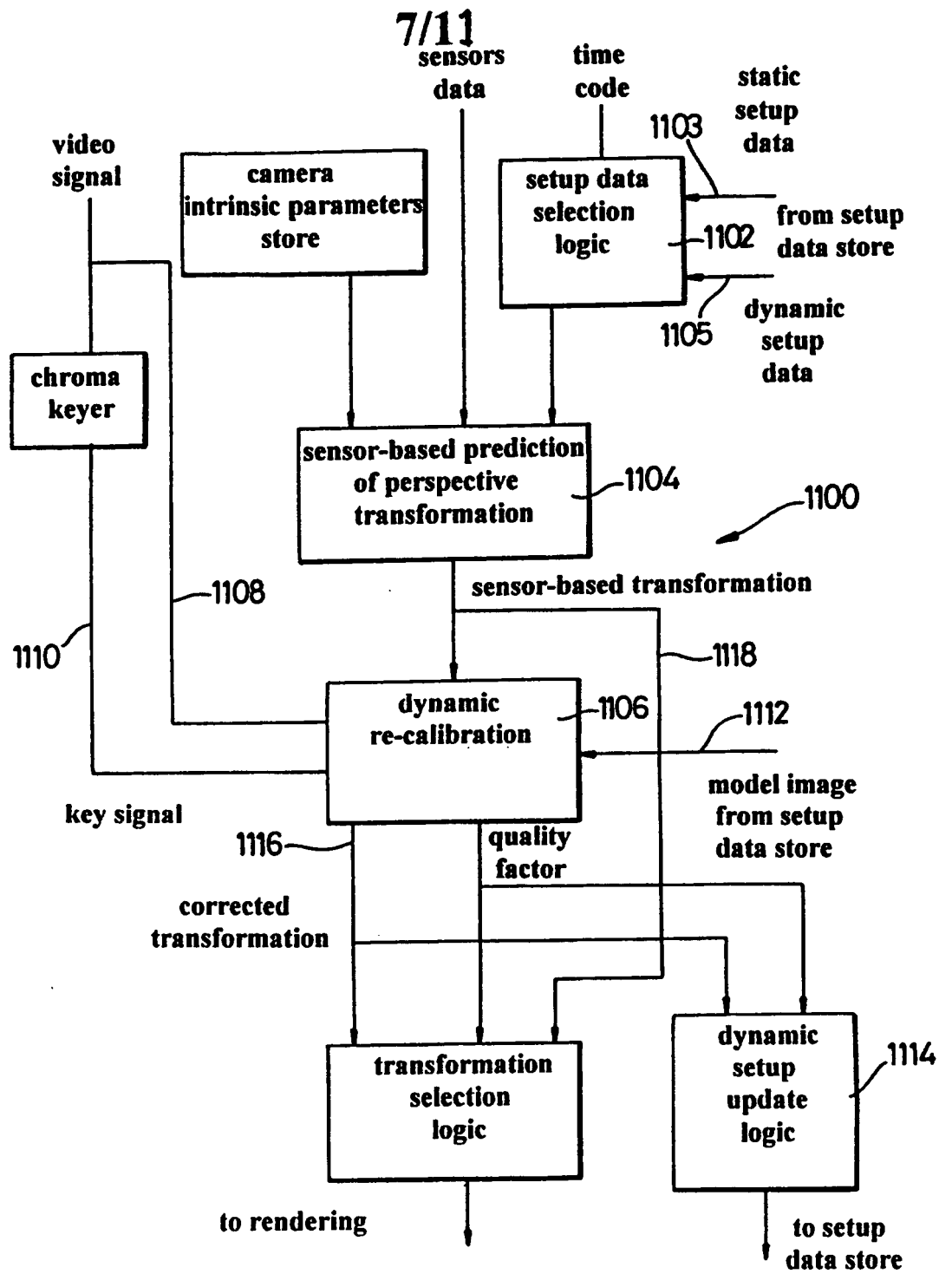

Fig. 11

camera intrinsic parameters store	
zoom Z1 focus F1	camera parameters record (1,1)
zoom Zm focus Fn	camera parameters record (m,n)

**camera parameters record:
magnification: Mx,My
center: Xc,Yc
aberrations: g1,g2,g3,g4,k1**

Fig. 12

9/11

1. setup rotation matrix

$$R_s = \begin{bmatrix} \cos(P_s) & 0 & -\sin(P_s) \\ 0 & 1 & 0 \\ \sin(P_s) & 0 & \cos(P_s) \end{bmatrix} \begin{bmatrix} 1 & 0 & 0 \\ 0 & \cos(T_s) & \sin(T_s) \\ 0 & -\sin(T_s) & \cos(T_s) \end{bmatrix}$$

600

2. prediction rotation matrix

$$R_p = \begin{bmatrix} \cos(P_p) & 0 & -\sin(P_p) \\ 0 & 1 & 0 \\ \sin(P_p) & 0 & \cos(P_p) \end{bmatrix} \begin{bmatrix} 1 & 0 & 0 \\ 0 & \cos(T_p) & \sin(T_p) \\ 0 & -\sin(T_p) & \cos(T_p) \end{bmatrix}$$

602

3. setup to prediction perspective transformation

$$R_{sp} = R_s^{-1} R_p$$

604

4. setup to prediction point transformation

$$u_p = \frac{R_{sp}[0][0]u_s + R_{sp}[1][0]v_s + R_{sp}[2][0]}{R_{sp}[0][2]u_s + R_{sp}[1][2]v_s + R_{sp}[2][2]}$$
$$v_p = \frac{R_{sp}[0][1]u_s + R_{sp}[1][1]v_s + R_{sp}[2][1]}{R_{sp}[0][2]u_s + R_{sp}[1][2]v_s + R_{sp}[2][2]}$$

606

5. image plane to frame-buffer

$$x = (u - A_u(u,v)) M_x + X_c$$
$$y = (v - A_v(u,v)) M_y + Y_c$$

608

Fig. 13

6. aberrations

$$A_u(u,v) = (g_1 + g_3)u^2 + g_4 uv + g_1 v^2 + k_1 u(u^2 + v^2)$$
$$A_v(u,v) = g_2 u^2 + g_3 uv + (g_2 + g_4)v^2 + k_1 v(u^2 + v^2)$$

610

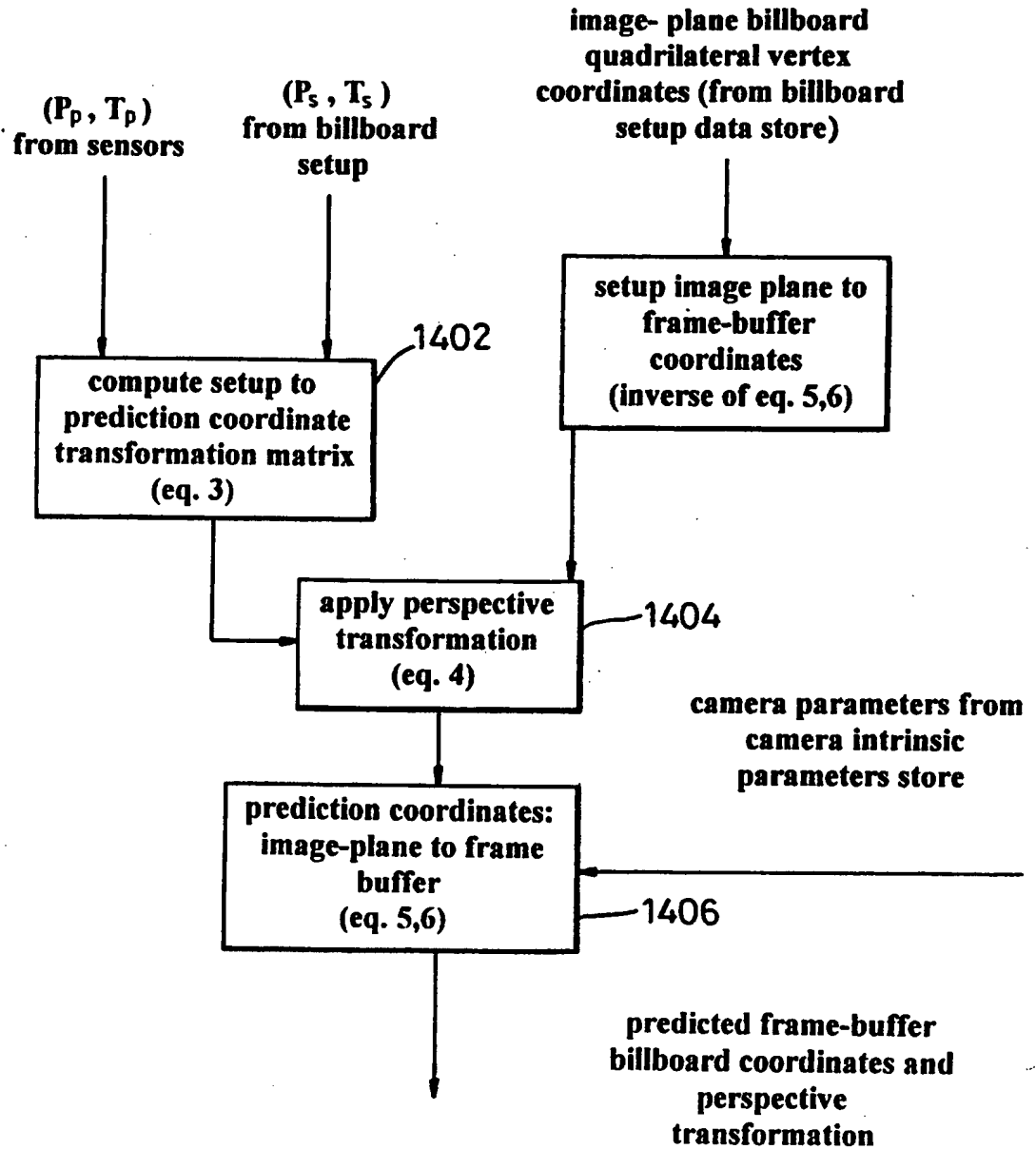

Fig. 14

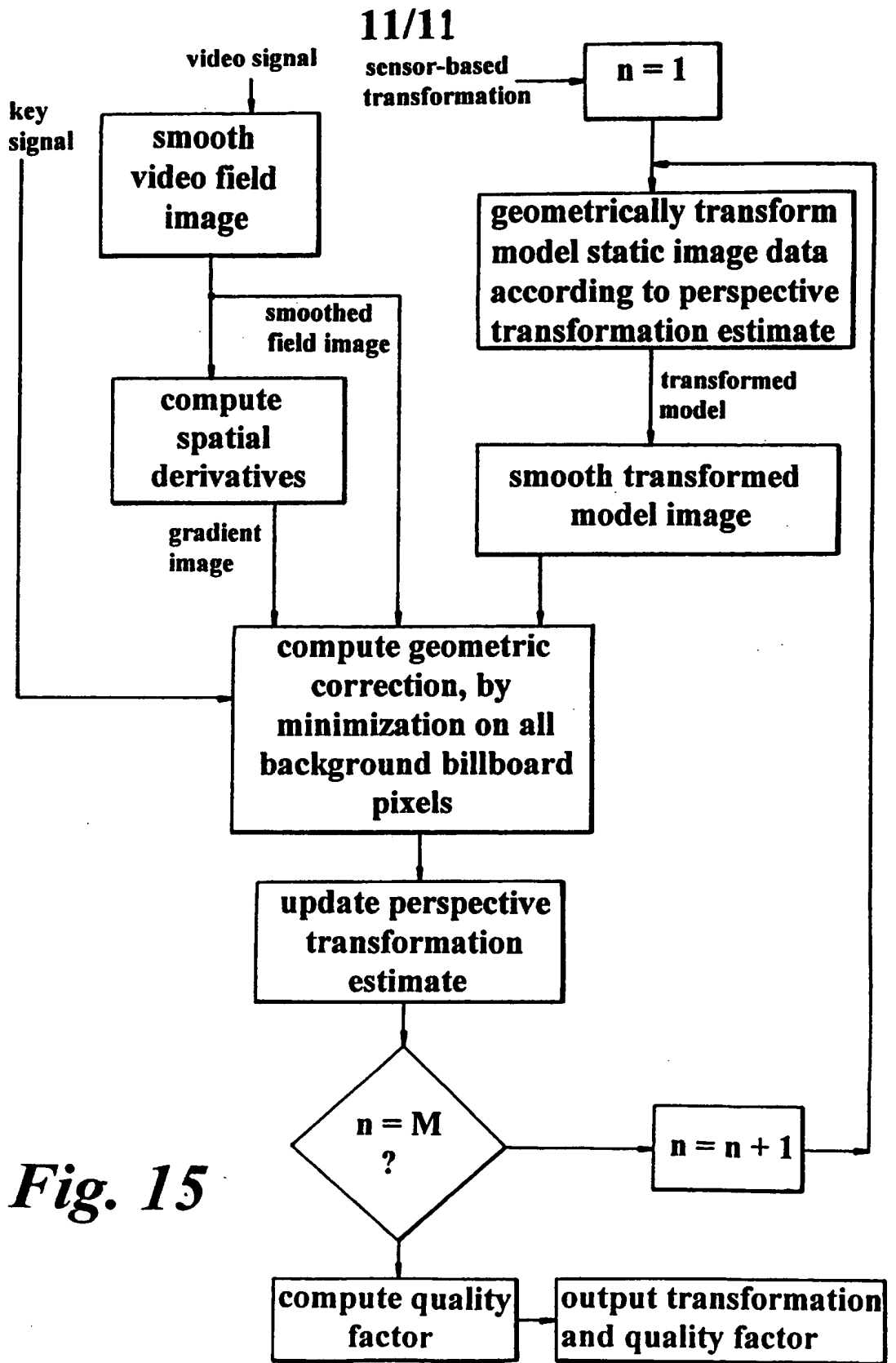

Fig. 15

**METHOD AND APPARATUS FOR AUTOMATIC ELECTRONIC
REPLACEMENT OF BILLBOARDS IN A VIDEO IMAGE**

5 The present invention relates to a method and apparatus for
automatically replacing billboards in a video image.

10 The present invention has particular use in electronic replacement
of billboards in a stadium or other venue but can be used to provide
accurate data relating to camera orientation for other purposes.

15 In previous systems it has been proposed to electronically replace
billboards in a stadium which are viewed by a viewer on television. The
billboards in the stadium are televised by a TV camera and the boards are
electronically altered so that the TV viewer at home sees a different board
to the spectator in the stadium or other venue.

20 The known systems such as those described in US 5,266,933, an
apparatus and method for electronically altering video images is disclosed.
The apparatus and method disclosed in the US patent and also in US
patent 5,353,392 whilst theoretically allowing replacement of billboards
do not solve the many practical problems encountered in real
environments. Most of these problems are related to the recognition and
replacement processes.

25 Relying entirely on pattern recognition techniques which utilize only
the video signal to identify and localise billboards for replacement
introduces major problems which affect the practical value of such a
system.

30 Clearly, any pattern recognition scheme, including those described

in US 5,264,933 and US 5,353,392 must rely on useful visible features in the image that can be compared with pre-defined descriptions. Such features should be located inside the billboard or at its neighbourhood.

5 In realistic situations, the visibility of these features might change, continuously or otherwise from practically zero to a some threshold visibility which allows the pattern recognition scheme to work properly. These changes can occur in the direction of growing or reducing visibility.

10 Such situations include :

- Acceleration or de-acceleration of camera motion introducing a huge amount of blur.
- Excessive zooming-in or zooming-out of the billboard.
- Excessive occlusion by players.
- 15 ● Entering or exiting a camera's field of view by any combination of pan, tilt and zoom operations.
- Any combination of the above mentioned mechanisms.

20 Therefore, in practical situations, a continuous replacement of billboards, is not possible. Even if an interrupted replacement was allowed, it would require a delay of at least a few seconds to decide whether the resulting replacement interval is acceptable or not. Such a delay is usually not permitted in live broadcasting of sports events.

25 Replacing arbitrary billboards introduces further problems. A seamless replacement requires to identify the foreground objects occluding the billboard in order to inhibit replacement at places of occlusion. Foreground objects mainly consist of players but also the ball or other objects. Consider now a player with a red shirt, occluding a part of a
30 similarly red portion of a billboard. Colour contrast cannot be used

robustly to identify occlusion. Furthermore, since the player is a non-rigid object, motion or shape information cannot be used accurately enough to guarantee perfect replacement.

5 Another problem which may arise in practical situation is resolution of billboard identity. Consider two identical billboards positioned at two different locations in the arena. Suppose different replacement billboards are assigned to each of these physical billboards, then one must be able to tell which one is which. This can prove to be extremely difficult
10 especially if no unambiguous features are visible.

This invention describes a robust system for billboard replacement, based on some or all of the following key-elements:

- 15 ● Pan, tilt, zoom and focus sensors attached to the camera, which enable after a proper set up procedure to estimate the presence and location of billboards in any given video field.
- Image processing methods and their embodiment which enable to refine the sensors' estimates.
- 20 ● Physical billboards which are coloured properly to enable the efficient detection of occlusion by chroma-key techniques.
- Colour variation or a pattern within the physical billboard for further enhancing the performance of the image
25 processing methods.

The present invention has a first object to provide a method and apparatus which enables identification of the location of a billboard or

other static object in a stadium or other venue in any weather conditions with any panning speed of the camera and with any other change in camera parameters.

5 The present invention therefore provides apparatus for automatic electronic replacement of a billboard in a video image including an automatic camera orientation measurement apparatus including motion measurement means operative to measure the Field of View (FOV) of the TV camera relative to a known reference position.

10

 The present invention also preferably provides apparatus for automatic electronic replacement of a billboard in a video image, including image processing means for processing video signals generated by the TV camera, in which said processing means includes calibration means for
15 periodically automatically calibrating the motion measurement means, apparatus in which the motion measurement means includes means for measuring the pan tilt, zoom or focus of the camera relative to known reference positions and apparatus in which the motion measurement means includes means for measuring the pan tilt, zoom and focus of the camera
20 relative to known reference positions.

 The present invention therefore uses dynamic recalibration to correct for residual sensor errors or aberrations in an imperfect model and for sensor drift over time. Thus it is possible in accordance with the
25 present invention to use less stable sensors and the apparatus and method in accordance with the present invention can accommodate movement in the camera position. The image correction process for calibration of the sensors eliminates the necessity to keep the sensors stable by mechanical means by recalibration automatically with reference to the video image.

30

In the initial set up procedure corrections can be incorporated for calibration for billboards which are, for example, not in the centre of the Field of View - for example a billboard which is in the top left-hand corner of the screen can be adjusted by, for example, 3 pixels to take into account aberrations in the camera.

Further problems which arise in the prior art systems are firstly when the billboard is either substantially totally occluded or secondly, is occluded by an object, such as a player, of the same colour as the real sign on the billboard.

This can firstly, as explained above, lead to non-recognition of the billboard and also secondly, to difficulty in satisfactory replacement of the billboard.

In the first case the real billboard can have already been replaced in the video image but if the camera zooms into a close up or if a different camera is used for the close up then the lock may be lost due to only a very small portion of the billboard being in view. In the second case the player may have on a strip which is the same colour as the billboard. The prior art systems propose to distinguish the billboard from the player on the basis of movement if the colours are the same and to analyse the "moving" pixels to determine occlusion. This is reasonable in theory but fails in practice since not all players are moving at all times. Thus, if a number of players move in front of a billboard and one player remains after the others have moved on, the electronics will not be able to distinguish on movement grounds. Since colours are distorted by floodlighting, shadows, differences in reflectivity and different lighting conditions for a foreground player and a background billboard, there will be occasions in practice where the system fails. In such cases either the

original billboard may re-appear on the video image or the replacement billboard will not be accurately occluded.

5 It is again possible to introduce a delay in the video transmission to enable the electronic signal processing to be more accurate but this does not solve the practical problem where a plurality of players move in different directions to occlude a billboard. The necessary delay is considered unacceptable and will in any case not solve all of the above problems.

10

In accordance with a preferred embodiment of the present invention it is proposed to replace the real billboards with chroma-key panels or with delineated areas forming chroma-key panels.

15 Chroma-key is essentially an occlusion technique allowing, for example, a news reader to stand and move about in front of a chroma-key board, usually coloured blue or another suitable colour. The news reader (foreground) is distinguished from the chroma-key board (background) by colour differentiation and can thus move in front of the replacement background with normal occlusion of the foreground and background. This technique is very well known in television studio systems and is described in numerous US patents, including US 2,974,190 and 4,200,980.

25 Recently, several systems which combine camera sensors with chroma-key for the purpose of coordinating the movement of the graphics backgrounds with those of the camera, have been described and demonstrated.

30 [Ref. K. Haseba et al., Real-timing compositing system of a real

camera image and a computer graphic image, International Broadcasting Convention, 16-20 Sep. 1994, Conference publication No. 397, IEE 1994, pp. 656-660].

5 In principle, such an arrangement could be used for billboard replacement where the sensors unambiguously solve the recognition problem and the chroma-key billboard helps to handle occlusion properly. However due to some major differences, this arrangement should be enhanced. These enhancements are the basis of the present invention.

10

 In a virtual set application, the camera is typically 2-10 metres away from the foreground and the entire field of view is usually replaced. In comparison, a billboard may be several hundred metres from the camera and therefore a replacement system using sensors is much more
15 susceptible to sensor errors:

- Due to the large focal distances, the same sensor accuracy will translate to larger geometric registration errors. Consider a rotary encoder of 81000 pluses/revolution, then
20 the angular precision is 0.0044 degrees or 75 micro-radians. The repeatability is twice as bad. Consider a shooting range of 100 m with a field of view of 4 metres, then the FOV is 40 milli-radian. The error translates to $768 \cdot 150 / 20000 = 2.88$ pixels.
- Since the field of view includes many stationary objects (including billboards) which are not replaced, the human observer will be much more sensitive to the registration errors. Additional errors may originate from lens distortion, rotation axis which does not pass through the focal point,
25 non-zero roll angle, etc.
30

Chroma-key is basically a technique for studios where the illumination is carefully designed and controlled and the controls of the chroma-keyer are carefully adjusted for the specific arrangement of blue-screen colour and illumination.

5

In a sports event, the conditions may be highly non-ideal and require some modification to the chroma-key algorithms. In particular, the keyer parameters should be adapted to the specific billboards being replaced due to changes in illumination across the arena.

10

Accordingly in the present invention it is proposed to use chroma-key panels and to replace these in the video image by the replacement billboards.

15

Since it is necessary for perfect occlusion that the players or other occluding objects are of different colour to the chroma-key panels, it is proposed in a further preferred embodiment to provide chroma-key panels in which the colour of the panel may be changed, for example, by using a rotating billboard structure which is known in the art. One side could, for example, be blue and another green. Green may be preferable in a sports environment since players tend not to wear green as this would not contrast with the background sports surface.

20

25

In a further preferred embodiment and in particular where a plurality of billboards require replacement, a patterned chroma-key board is used. The pattern may be of any suitable shape but is preferably selected to be suitable for the size and shape of the billboard or series of billboards and also to the anticipated video conditions. Thus if a billboard is only able to be viewed from a long distance then a different pattern will be selected to a billboard which is to be viewed in close up.

30

The pattern may comprise different colours or may be different shades of the same colour. The pattern may comprise vertical and horizontal lines or may comprise a decorative pattern, a discernible advertisement, company logo or other suitable wording which may be more aesthetically acceptable.

The use of a pattern allows further discrimination of the position of the camera and may allow movement of the camera from a fixed position.

The camera orientation data can be transmitted together with the video signal and will identify the position of the billboard in any weather, lighting or occlusion conditions. No reference is required to any feature within the sports venue to identify the position of the billboard.

The camera sensors can be accurate to a few pixels or in physical terms to approximately 1 cm at a range of about 100 metres thereby enabling accurate replacement of any billboard. The recalibration can be carried out continuously or only periodically, particularly if an initial adjustment of the calibration of billboards not in the centre of the FOV is recorded on set up.

By use of the chroma-key techniques there is no requirement to transmit any occlusion data since this can be readily inserted at a receiver and the occlusion inserted in the normal manner.

In a preferred arrangement within a stadium or other sports venue real billboards with normal advertising material will be situated on one side of the stadium to be viewed by a first plurality of cameras and chroma-key billboards will be situated on another or the opposite side to

be viewed by a second plurality of cameras. This, for example, the home nation may view the normal billboards, with the international TV audience seeing only substituted boards.

5 The present invention also provides a method for electronically replacing a billboard in a video image display, generated by a camera, comprising the steps of :

- 10 a. identification of the position of a rectangular billboard in a stadium or other venue, said identification step comprising specifying on the video display the billboard to be replaced by identification of its four corners at a first camera position;
- b. storing the identification information;
- c. monitoring the movement of the camera in pan, tilt and
15 zoom;
- d. storing the monitored movement of the camera on a field by field basis; and
- e. analysing the size and position of the billboard to be replaced from the information recorded in its first known
20 position and the stored movements of the camera to provide information relating to the size, perspective and position of the billboard in the present video field;
- f. storing in a billboard replacement store a replacement billboard to be used in replacement of the billboard in the
25 stadium;
- g. electronically altering the size and perspective of the replacement billboard in accordance with the camera motion information to conform to the size and perspective of the billboard to be replaced in the present video frame; and
- 30 h. electronically replacing the billboard in the present video

frame by the replacement billboard.

5 In a preferred embodiment the step of analysing the size and position of the billboard to be replaced comprises a further step of analysing a plurality of video scan lines to provide fine adjustment information relating to the exact size, perspective and position of the billboard to be replaced.

10 In a further preferred embodiment the billboard to be replaced is blank and is of colour suitable for chroma-key replacement. Such colour may be of a blue or green shade, due to the fact that these colours are rarely found in human skin and hair.

15 In a still further preferred embodiment the chroma-key billboard is patterned with a pattern of a suitable shape for the purpose of facilitating the fine adjustment process mentioned above. The step of analysis of the size and position of the billboard comprises the analysis of the pattern to ascertain the exact position of the billboard.

20 In a further embodiment the correction of the sensor-based prediction by the analysis of the pattern will be controlled by a figure of merit (accuracy estimate) for the analysis, which will be computed automatically.

25 In a further embodiment the step of electronically replacing the billboard in the present video field by the replacement billboard include the step of superimposing occluding objects by use of the chroma-key techniques.

30 In a further preferred embodiment the billboard to be replaced can

be changed to best match the colours and shades of colours on the players costumes, for the purpose of providing a good contrast between the billboards and the players. For example, if these costumes contain shades of blue, then a green billboard may be selected.

5

The backing colour can be selected between blue, green and red. In order for the chroma-keyer to calculate all parameters necessary to perform proper image compositing, the system requires a sample of the background colour as reference. This step can be done automatically by scanning the image and detecting the purest and brightest colour. Advanced chroma-keyers enable the user to manually select the area to be sampled.

In a further preferred embodiment the chroma-key apparatus will have a multiplicity of set up conditions, each corresponding to a different region of the stadium. The camera pan, tilt and zoom information will allow to load the corresponding set up conditions.

In a further embodiment, the fine adjustment information will be used to compensate drift errors of the sensors. In a practical situations, the sensor error will have a significant portion which is at temporal frequencies which are much lower than the video field rate. Thus these sensor-induced errors can be reliably estimated from good video field and subtracted from subsequent measurement.

25

The present invention also provides apparatus for carrying out the method of electronically replacing the billboard as specified hereinbefore.

Embodiments of the present invention will now be described, by way of example with reference to the accompanying drawings in which :-

30

Figure 1 shows a stadium or other venue illustrating the apparatus according to the present invention;

Figure 2 shows the video image of the stadium as seen by the camera in a first position;

5 Figure 3 illustrates a stadium with billboards in several different positions;

Figure 4 illustrates a zoomed camera shot of a billboard illustrating the problem with prior art systems;

10 Figure 5 shows a patterned chroma-key billboard for use with the present invention;

Figure 6 shows in block diagrammatic form circuitry associated with the camera arrangement of Figure 1 for transmitting video data and camera orientation data;

15 Figure 7 shows in block diagrammatic form receiver circuitry for co-operation with the transmitter circuitry of Figure 6;

Figure 8 shows a flow diagram for the operation of the circuitry of Figure 7;

Figure 9 shows an arrangement for a billboard setup data store;

Figure 10 shows an arrangement for billboard setup data;

20 Figure 11 shows a flow diagram for perspective transformation computation;

Figure 12 shows an arrangement for camera intrinsic parameters store;

Figure 13 shows equations for dynamic recalibration;

25 Figure 14 shows a flow diagram for dynamic recalibration; and

Figure 15 shows the process of recalibration.

With reference now to Figures 1 to 4 the principle of the present invention is now explained.

30 In a stadium or other venue 10 billboards 14,16,18 are installed at

the side of a pitch represented by markings 12. These billboards are viewable by a camera 20. Billboards 15,17,19 may be present on the opposite side of the stadium for viewing by a further camera 21. The stadium terraces/seating are shown diagrammatically by the lines 11.

5

Camera 21 may in a preferred example be a normal TV video camera and will transmit its output video signal directly to a first feed which may serve the local population. Although we refer to camera 20 or 21, it may be clearly understood that there could be a plurality of cameras on each side of the stadium providing differing views.

10

Camera 21 in a preferred embodiment will televise boards 15,17,19 which will be transmitted to the local population in an unchanged manner.

15

Camera 20 will in this preferred embodiment transmit a feed to an international audience. Camera 20 is equipped with orientation sensing means which preferably comprises one or more of the following :

20

pan measurement means 24;

tilt measurement means 25;

zoom measurement means 26; and

focus measurement means 28.

25

Suitable sensors may comprise the Virtual Reality Encoder from RADAMEC EPO, Bridge Road, Chertsey, Surrey KT16, 8LJ, England.

30

Dependent on the allowed mobility of the camera only one, several or all of these may be required. For example, if camera 20 is fixed in pan and tilt and focus and can only zoom, as in the case of some remotely controlled unmanned cameras then only the zoom parameter need be measured.

Most cameras in sports stadiums can zoom, tilt and pan and it is assumed that these parameters are measured for each camera as now explained. The focus is assumed to be fixed but in similar manner the parameter could be added if required.

5

Figure 2 shows the video image as seen by a viewer and in particular by the operator of the equipment. The camera 20 is zoomed, panned and/or tilted to "centre" the billboard 14 in a suitable position and at a reasonable size. With reference to Figure 7 each billboard is then
10 viewed at a receiver and its position is marked preferably by using a touch screen 700, or keyboard mouse 702 and marking the four corners. The positions are stored in a store 704.

For billboards higher in the stadium such as 30 (Figure 3) a
15 correction factor for the camera may be stored dependent on the tilt position of the camera.

Each billboard position is stored in store 704 together with the camera parameter information at the reference position for the camera 20
20 obtained from the camera parameter information which is correct at the time that the billboard position is stored.

The following procedure is preferably repeated for each of the cameras and for each of the target billboard :

25

1. Point the camera at the target to obtain a stable unoccluded view of the target. Adjust the zoom to get a large view of the target yet keeping the whole target within the field of view.
2. While the camera is not moving trigger an acquisition device, to
30 grab a picture of the target, as well as the corresponding readings

of the sensors.

3. Mark the corners of the target, on the video image.

5 Preferably a corner detector is used to pinpoint the corners of the target at sub-pixel precision.

This camera parameter information is obtained (Figure 6) from the sensors mounted on the camera and the camera movement is referenced to a first or fixed reference position for each parameter. The movements
10 of the camera are sensed and the signals are fed into a combiner circuit 24 and then to a transmit buffer 36 from which the combined video and position data signals are transmitted.

During set up, at the receiver (Figure 7) the receive buffer 706
15 receives the signals and feeds these to a splitter 708. The video signal is stored and delayed in a suitable store 710 and the camera parameter data is extracted and stored in store 712.

In set up the VDU 700 is used to mark each billboard that may
20 require replacement. The camera 20 is panned etc to move each billboard into a suitable position on the screen and its position is recorded in the billboard store 704 together with the camera parameters obtained from store 712 via processor 714.

25 A replacement billboard store 716 stores a plurality of replacement billboards and these are selectable to be able to replace the original billboard.

The replacement billboard is in operation inserted into the video
30 signal in a combiner 718 to provide a modified output video signal 720.

The setting up procedure can also identify billboard locations and camera parameters for several cameras by storing a camera ID from a source 30 (figure 6). Thus, billboard position store 704 will store separate lists of billboard data for each camera.

5

The operation of the system will now be described with reference to a single billboard and a single camera 20.

With reference to Figure 4, it is assumed that billboard 14 enters the field of view in an enlarged form on the left-hand side of the screen as camera 20 pans following zooming from the Figure 3 position.

The camera orientation data is constantly being received by the receiver and the processor 714 will constantly match on a pixel by pixel basis the video image with the known billboard position stored in store 704. As soon as the billboard appears in the video image the pixels representing the billboard will be identified and the replacement billboard pixels which relate to those pixels will be substituted in the combiner 718. The delay will be minimal since the identification of the pixels is by an address correlation process which will be virtually instantaneous.

After a period of time the camera sensors may drift and in this case the replacement billboard may not exactly align with the original. This may only be by one or two pixels and may not be discernible to the viewer. To correct this two solutions are possible. Firstly, the billboard position can be manually restored periodically at a suitable time, for example, when a camera is not active. This requires the co-operation of the operator.

Secondly, a comparison can be made on a pixel by pixel basis of

30

the billboard against an original stored billboard and an adjustment of the reference camera parameters can be made in billboard position store 704. This process can be done automatically at either set intervals or when the processor 714 has a suitable time slot.

5

The essential steps of a preferred recalibration process are to perspectively transform the current video image using the camera data to provide an estimated transformed model. A stored image of the billboard is then compared with the transformed model to provide a residual video
10 field. The residual distortion between the transformed model and the residual video field is resolved to provide updating information for updating the estimated transformation and to thereby provide a calibration correction factor for recalibrating the position of each billboard in the store in accordance with the camera sense information.

15

The replacement of each billboard is accomplished by use of the processor 714 (Fig. 7) and the various parameter and billboard stores using appropriate software programmes as now described in more detail.

20

Figure 8 describes the complete process which allows to determine the position of each billboard in the camera's field of view, and render the corresponding part of the billboard into the frame buffer. Since the rendering and later the compositing of the graphics buffer with the video buffer by means of chroma-key are known art, we will concentrate on the
25 billboard position determination with reference also to Figures 6 and 7.

At the beginning of each video field, the pan, tilt, zoom and focus sensors (24,25,26) are read 800. These values, combined with billboard data from billboard setup data store 704 and camera data from camera
30 intrinsic parameters store 712, enable the detection and recognition of all

billboards in the camera's FOV, independently of the video signal. The processing of Fig. 1 consists of a loop on all billboards (m) 802,804. For each billboard, its setup data is retrieved 806 from billboard setup data store 704 and used with camera intrinsic parameters 808 to compute the perspective transformation 810 from billboard m to current field. The replacement billboard information is then stored (812) in a frame buffer.

Fig. 9 describes the billboard setup data store 900 which consists of a separate record 902..904 for each billboard in the arena. Such a record consists of a static image 906 grabbed in favourable conditions and of the corresponding static setup data 908. The record also consist of dynamic setup data 910 which is computed using the image processing means in a process known as dynamic re-calibration which has been briefly described above and will be further described with reference to Figure 11.

Fig. 10 describes the setup data (either static or dynamic) 1000 for a single billboard. It consists of the sensors' readings 1002 at the setup instance, the billboard quadrilateral vertex 1004 coordinates and the time-code of the setup instance 1006.

The method of dynamic re-calibration can be explained as follows:

Due to sensors' drift and inaccuracies, a final calibration table and other practical reasons, it is impossible to predict the exact location of all visible billboards at a given instance. However, at many video fields, a billboard's visibility may be such that an exact geometric position correction can be performed. Since that position is closer both temporally and spatially to the subsequent video fields, it is preferable to rely on that "luck shot" by predicting the billboard position relative to its sensors'

readings and exact quad coordinates. Consider for example a billboard which exits the field of view due to camera panning. Having a luck shot while it is still highly visible, allows the smooth tracking of the billboard by sensors only, when its visibility does not allow any image processing means to be applied.

Fig. 11 depicts the flow diagram 1100 for perspective transformation computation. A setup data selection logic 1102 selects either the static 1103 or the dynamic 1105 setup data from the setup data store 806 as described above. This setup data, together with camera intrinsic parameter is used to compute a sensor-based prediction of the perspective transformation 1104, independently of the video signal.

A dynamic re-calibration 1106 based on image processing means is then applied to the prediction. It utilizes the video 1108 and chroma-key 1110 signals as well as the billboards model image 1112 from the setup data store 806 (Fig. 8). Based on a quality factor derived from the image processing means, either the sensors-based 1118 or the corrected transformation 1116 are output. If the estimated quality of the geometric correction is high, then the dynamic setup data is updated 1114.

Figs. 12,13,14 describe the sensor-based prediction of billboard coordinates in the video field. Such a prediction utilizes the sensors reading as well as the camera intrinsic parameters. These parameters are described in Fig. 12 and have to be tabulated for a dense sampling of the (zoom,focus) space. The meaning of these parameters is clear from Figure 13 to which reference is now made.

Let the set of measurements given by the pan, tilt, zoom and focus sensors be represented by the vector (P,T,Z,F). The tilt angle is assumed to be relative to the horizon.

Consider an object point whose image at some setup instance is, at frame-buffer coordinates (x_s, y_s) . Let also the sensor measurement vector at that instance be (P_s, T_s, Z_s, F_s) .

5 At another instance, the prediction instance, let the sensor measurements vector be (P_p, T_p, Z_p, F_p) . It is required to predict the location of the object point in frame-buffer coordinates (possibly out of the actual frame-buffer), (x_p, y_p) .

10 To enable the procedure we define the setup rotation matrix as shown at 600 and the prediction rotation matrix is defined as shown at 602.

15 Then, the perspective transformation matrix between the two image-plane coordinate systems is given as shown at 604 and 1402 (Fig. 14).

R_{sp} is a 3*3 matrix with row and column indices ranging from 0 to 2. $R_{sp}[i][j]$ denotes the term in row i , column j in the matrix. Thus, given the setup image-plane coordinates of the object point (u_s, v_s) , the
20 predicted location of the object point in image-plane coordinates (u_p, v_p) is given as shown at 606, 1404.

Image-plane to frame-buffer coordinate transformation is achieved as shown at 608, 1406. Aberration compensation is achieved as shown
25 at 608, 1406 (Fig. 14) to provide predicted frame buffer billboard coordinates and perspective transformation data.

An effective way of deriving these parameters for a specific (zoom, focus) pair is described in [J. Weng et al., Calibration of stereo
30 cameras using a non-linear distortion model, IEEE 10th Intl. Conf. Pattern

Recognition (1990), pp. 246-253]. The image processing means for geometric correction, which allow also the process of re-calibration, is now described with reference to Fig. 15.

5 The image processing means for geometric correction of sensors-based prediction are based on the differential method for motion estimation [C. Cafforio and F. Roca, The differential method for motion estimation, in: T.S. Huang, eg., Image sequence processing and dynamic scene analysis, Spring, Berlin, 1983, pp. 104-124]. Let C be the current video
10 field and let M be the static billboard setup image, perspectivevely transformed according to the sensors-based prediction. Here we consider only luminance images. Ideally, M and C are identical within the support of the billboard quadrilateral. Actual differences may include:

- Occlusion present in C but not in M.
- 15 ● Geometric errors due to sensors and intrinsic camera parameters errors.
- Luminance changes.

Neglecting for the moment any difference which is not due to
20 geometric errors, consider a point (x,y) inside the support of the billboard quadrilateral. Let (p,q) be the local geometric error then we may write for the luminance signals of the respective images:

$$M(x + p, y + q) = C(x, y)$$

Under the assumption that the error is small, one may write a
25 Tailor series expansion:

$$M(x + p, y + q) = M(x, y) + p \frac{dM}{dx} + q \frac{dM}{dy} + (\text{Second order terms})$$

Neglecting the second order terms and denoting the spatial derivatives

$$dM/dx = H$$

$$dM/dy = V$$

we obtain

$$C(x,y) - M(x,y) = pH + qV$$

5

Also denoting the differences $C(x,y) - M(x,y)$ by D we obtain

$$D = pH + qV$$

10 The equation above holds, locally. For a global billboard solution, and small error assumption we may use the perspective model [G. Adiv, Determining Three-Dimensional Motion and Structure from Optical Flow Generated by several moving objects, IEEE Trans. Pattern Analysis and Machine intelligence, 7, pp. 384 - 401, 1985].

15

$$p(x,y) = \frac{a_1x + a_2y + a_3}{a_7x + a_8y + 1}$$
$$q(x,y) = \frac{a_4x + a_5y + a_6}{a_7x + a_8y + 1}$$

20

The coefficients a_1, \dots, a_8 are computed by minimizing the following expression:

25

$$\sum_{(x,y)} (D(x,y) - p(x,y)H(x,y) - q(x,y)V(x,y))^2$$

30 Now, the perspective transformation matrix (based on sensors' prediction) is multiplied by:

$$\begin{bmatrix} a_1 & a_4 & a_7 \\ a_2 & a_5 & a_8 \\ a_3 & a_6 & 1 \end{bmatrix}$$

5 The matrix obtained can be considered to be the updated prediction of billboard perspective.

In a practical environment the following considerations may apply.

- 10 ● Occlusion may cause major problem in this formulation, since if pixels from occluding and moving objects participate in the minimization of the expression above they might bias the solution significantly. Preferably, such pixels are discarded from processing by using chroma-key panels. A key signal output by a chroma-keyer, is preferably utilized to discard these pixels.
- 15 ● Luminance variations can be minimized by pre-processing the current video field, using histogram matching techniques.
- The prediction-correction process may require 2-3 iterations to converge.
- 20 ● Noise immunity and convergence can both be enhanced by pre-smoothing the images.

 Thus the billboards 14 etc are preferably chroma-key boards and occlusion is by colour discrimination using the normal chroma-key techniques. These techniques will enable perfect occlusion providing that
25 the players do not wear any colour which is the same as the board. This may not always be possible and it is proposed in accordance with a particular embodiment of the present invention to use boards which can rotate or otherwise change to a second or third colour. For example, three colours may be blue, green and red which may be selected when the
30 colour of the players strips are known.

In a preferred embodiment chroma-key apparatus can comprise the ULTIMATTE-7 digital video image compositing device from ULTIMATTE Corp., 20554 Plummer St., Chatsworth, CA 91311, USA.

- 5 The backing colour can be selected between blue, green and red. In order for the chroma-keyer to calculate all parameters necessary to perform proper image compositing, the system requires a sample of the background colour as reference. This step can be done automatically by scanning the image and detecting the purest and brightest colour.
- 10 Advanced chroma-keyers enable the user to manually select the area to be sampled.

- In a particular embodiment it is proposed to use a patterned chroma-key panel. Calibration of the camera sensors can then readily be
- 15 accomplished by comparison of the pattern on a pixel by pixel basis. The pattern on the billboard panel should preferably have critical dimensions less than anticipated sensors error (projected to world coordinates).

- In summary, the above system can operate even in extremely poor
- 20 weather conditions since the electronic processing circuitry knows exactly where each billboard is situated and does not rely on any analysis of the video image to detect the billboard. In the event that the video image is so distorted that recalibration cannot be carried out with reasonable certainty, then the original camera parameter settings can continue to be
- 25 used since the video image as viewed will be of poor quality and thus the viewer will not notice an error of one or two pixels in the positioning of the replacement billboard which will require to be displayed in an equivalent quality which matches the poor quality video image.

30

CLAIMS

1. Apparatus for automatic electronic replacement of a billboard in a video image including an automatic camera orientation measurement apparatus including motion measurement means operative to measure the
5 Field of View (FOV) of the TV camera relative to a known reference position.

2. Apparatus for automatic electronic replacement of a billboard in a video image as claimed in claim 1, including image processing means for
10 processing video signals generated by the TV camera, in which said processing means includes calibration means for periodically automatically calibrating the motion measurement means.

3. Apparatus as claimed in claim 2 in which the motion measurement
15 means includes means for measuring the pan tilt, zoom or focus of the camera relative to known reference positions.

4. Apparatus as claimed in claim 2 in which the motion measurement means includes means for measuring the pan tilt, zoom and focus of the
20 camera relative to known reference positions.

5. Apparatus as claimed in claim 2 further including a billboard in which said billboard comprises a chroma-key panel.

- 25 6. Apparatus as claimed in claim 5 in which the panel comprises a patterned chroma-key panel.

7. Apparatus as claimed in claim 6 in which the pattern comprises two different colours or two different shades of the same colour.

30

8. Apparatus as claimed in claim 7 in which the pattern is designed to be optimised for use according to the size and shape of the billboard and to the anticipated video conditions.

5 9. Apparatus as claimed in claim 2 in which the calibration means includes fine adjustment image processing means including means for
perspectively transforming the current video image to provide an estimated
transformed model, means for storing a replica of the billboard image,
means for comparing the perspectively transformed video image with the
10 stored replica to provide a residual video field, means for solving residual
distortion between the transformed model and the residual video field and
means for updating the estimated transformation by means of the residual
distortion to provide a calibration correction factor.

15 10. Apparatus as claimed in claim 9 in which said means for storing the
residual distortion includes analysis means based in the spatial derivatives
of the current image of the transformed model as well as means for
analysing pixel by pixel the image differences of the transformed model
and the current image.

20

11. Apparatus as claimed in claim 9 in which the fine adjustment means includes means for carrying out the fine adjustment in an interactive manner.

25 12. Apparatus as claimed in claim 10 in which the pixel by pixel
analysis means includes means for discarding pixels using colour variation.

13. Apparatus as claimed in claim 2 including means for recording
calibration data obtained during a set up period when no occlusion is
30 present.

14. Apparatus for automatic measurement of camera orientation including means for measuring the Field of View (FOV) of the camera relative to a known reference position, and including image processing means for processing the video signals generated by the camera, said
5 image processing means including calibration means for periodically calibrating the motion measurement means.

15. A method of automatic replacement of a billboard in a video image said method comprising the steps of:

10 recording the Field of View (FOV) of a TV camera in a first reference position;

storing the image viewed by the TV camera in said first reference position;

15 measuring the movement of the camera relative to the first reference position and recording the measurements and periodically automatically calibrating the motion measurements by comparison of the present video image produced by said TV camera with the stored video image in said reference position;

20 calibrating a difference signal for recalibration of the motion measurements and said first reference position and replacing a real billboard in said cameras field of view with a virtual replacement billboard in accordance with said recalibrated first reference position.

16. A method as claimed in claim 15 in which said step of measuring
25 the movement of the camera relative to the first reference position comprises the steps of measuring the pan tilt, zoom or focus of the camera.

17. A method as claimed in claim 15 in which said step of measuring
30 the movement of the camera relative to the first reference position

comprises the steps of measuring the pan tilt, zoom and focus of the camera.

18. A method as claimed in any one of claims 15 to 17 in which the
5 billboard comprises a chroma-key panel and in which said step of replacement of the real billboard by the virtual billboard includes the step of occluding said replacement billboard by any object occluding said real billboard.

10 19. A method as claimed in any one of claims 15 to 18 in which said step of periodically automatically calibrating the motion measurements includes a fine adjustment image processing step including perspectively transforming the current video image to provide an estimated transformed model, storing a replica of the billboard image, comparing the
15 perspectively transformed video image with the stored replica to provide a residual video field, solving residual distortion between the transformed model and the residual video field and updating the estimated transformation by means of the residual distortion to provide a calibration correction factor.

20

20. A method as claimed in claim 19 in which said step of storing the residual distortion includes analysis based in the spatial derivatives of the current image of the transformed model and analysing pixel by pixel the image differences of the transformed model and the current image.

25

21. A method as claimed in claim 19 in which the fine adjustment step comprises carrying out the fine adjustment in an interactive manner.

22. A method as claimed in claim 20 in which the pixel by pixel
30 analysis step includes discarding pixels using colour variation.

23. A method as claimed in claim 15 in which said step of recording calibration data is carried out during a set up period when no occlusion is present.

5 24. A method as claimed in claim 15 in which said step of calibrating a difference signal is carried out only when the present video image is above a predetermined quality factor.

10 25. A method as claimed in claim 24 in which said virtual replacement billboard is positioned at the last recalibrated position in the event that a recalibration is not possible due to the present video image being below the predetermined quality factor.

3!

Patents Act 1977
Examiner's report to the Comptroller under Section 17
(The Search report)

Application number
 GB 9518439.6

Relevant Technical Fields

(i) UK Cl (Ed.N) H4F FAAD, FAAP, FAAX,
 FGG, FGH, FGJ, FGS, FGT

(ii) Int Cl (Ed.6) H04N 5/262, 5/265, 5/268, 5/272,
 5/275, 5/225, 5/232

Databases (see below)

(i) UK Patent Office collections of GB, EP, WO and US
 patent specifications.

(ii) ONLINE: WPI

Search Examiner
 MR J P COULES

Date of completion of Search
 4 DECEMBER 1995

Documents considered relevant
 following a search in respect of
 Claims :-
 1-25

Categories of documents

- | | |
|--|---|
| <p>X: Document indicating lack of novelty or of inventive step.</p> <p>Y: Document indicating lack of inventive step if combined with one or more other documents of the same category.</p> <p>A: Document indicating technological background and/or state of the art.</p> | <p>P: Document published on or after the declared priority date but before the filing date of the present application.</p> <p>E: Patent document published on or after, but with priority date earlier than, the filing date of the present application.</p> <p>&: Member of the same patent family; corresponding document.</p> |
|--|---|

Category	Identity of document and relevant passages	Relevant to claim(s)
X	GB 2271241 A (BBC) see Abstract	1, 14 and 15
X	GB 2013448 A (QUANTEL) see Abstract	1, 14 and 15
X	GB 2002989 A (NIPPON ELECTRIC) see Abstract	1, 14 and 15
X	WO 93/06691 A1 (DAVID SARNOFF) see Abstract	1, 14 and 15
X	US 5353392 (MULTI MEDIA) see Abstract	1, 14 and 15
X	US 5264933 (PRINCETON ELECTRONIC) see Abstract	1, 14 and 15

Databases: The UK Patent Office database comprises classified collections of GB, EP, WO and US patent specifications as outlined periodically in the Official Journal (Patents). The on-line databases considered for search are also listed periodically in the Official Journal (Patents).